



Project Office

Vol 2

Project Office is a design and research collaboration of staff and students. It is an architecture consultancy concerned with ethical, social and resilient architecture and design. We work with like-minded communities, organisations and individuals.

/ ABOUT US

Project Office is co-directed by Craig Stott and Simon Warren, senior lecturers in Architecture. We have undertaken diverse projects within the Leeds City region, and we are now beginning to develop projects that broaden our scope nationally and overseas. We offer a full architectural service that includes feasibility studies, design guides and design advocacy, fabrication and construction. Project Office is unique in that we utilise the power of student led design and research to provide concept proposals for organisations such as charities and community associations who are unable to afford standard architectural consultancy. Student participants are always paid for their time, either financially (working directly for Project Office) or through the University currency of 'credits' awarded towards their degree. The Project Office approach equips students with a fantastic pedagogic experience relating to real world complexities through the vehicle of live projects, whilst simultaneously supporting the needs of socially conscious organisations.

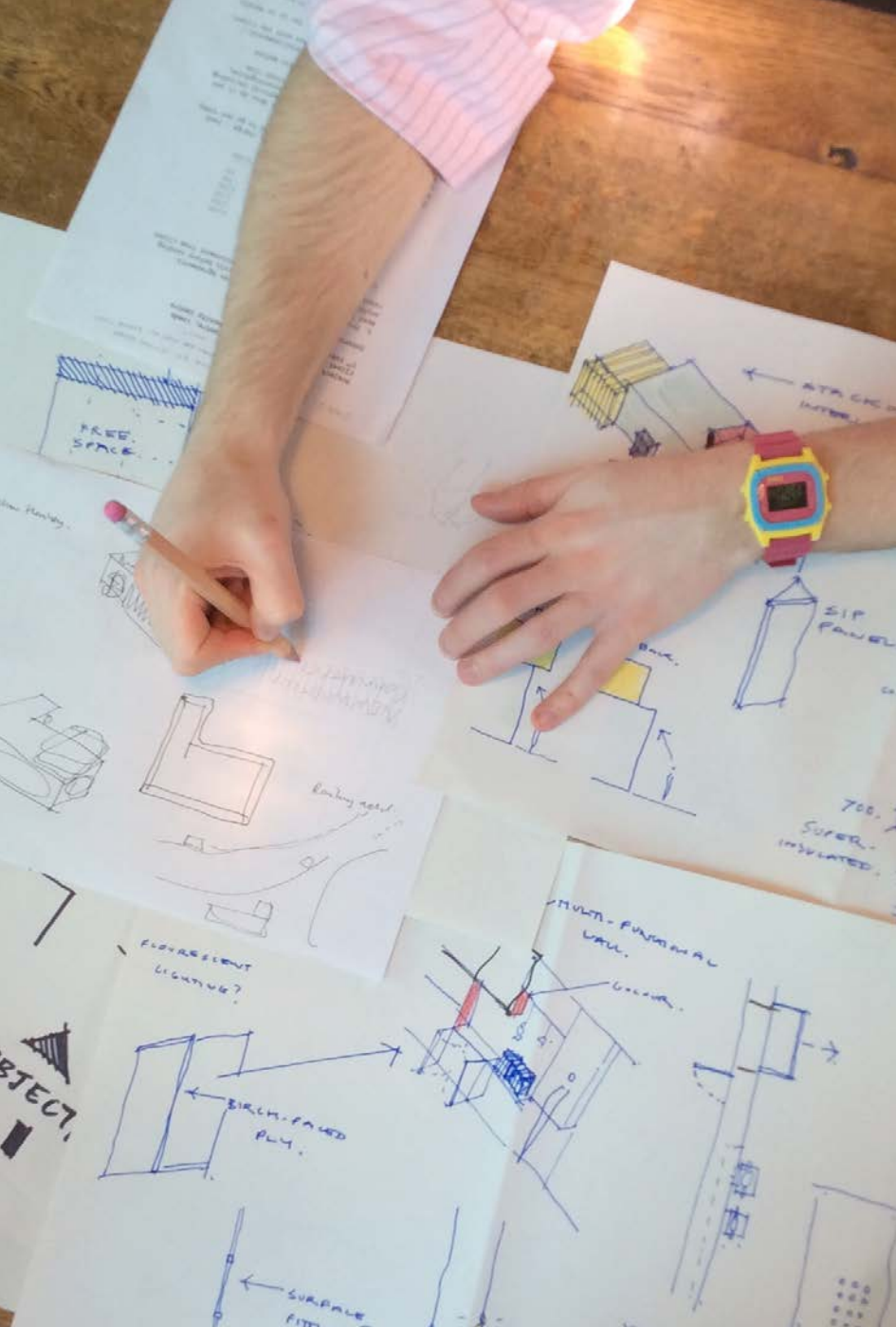

Storage, ~~room~~
space

We Need
a Common
Communal Space
with bar/food

NEED
Social
Space

EP209
Space

/ A FORCE FOR GOOD

As Awan, Schneider and Till in *Spatial Agency* reflect ‘If you ask a potential architecture student why they want to study architecture, the most common response is along the lines of “I want to design buildings and make the world a better place”’. If architects are meant to ‘do good’, isn’t this something we should uphold as a desirable professional virtue. For most, the world is a precarious place and now more than ever architects are well placed to make a difference to the lives of people.

The overarching pedagogical value of live projects is their potential impact as a *force for good*. Live projects equip students to make informed choices about the kind of architect they would like to be; particularly in raising the issues of their position regarding social responsibility.

For many students, perhaps in part because of their induction to design-studio, thoughts of social responsibility remain disconnected or at least dormant. They are taught that the focus is mostly on the ‘self’, the figurehead designer, and this is perpetuated by the architecture journals and websites they readily absorb. This, as we know, is not the reality in a world wrestling with global imperatives of climate change, energy depletion, increasing population and an ever increasing divide between rich and poor.

Finally, live projects achieve straightforward meaningful contributions (physical or otherwise) to our communities and built environment. In every school of architecture the one resource we have in abundance is the student, this can be harnessed as a force for good. I would suggest that if all our schools of architecture carried out live projects then we could create a beneficial legacy in the wider community, the upshot could be that that this also has a positive impact on the public perception of our profession.

Simon Warren

Warren, S. (2014). *The Fareshare Project*, West Yorkshire, UK. In: H. Harriss and L. Widder, ed., *Architecture Live Projects: Pedagogy into Practice*, 1st ed. London: Routledge.

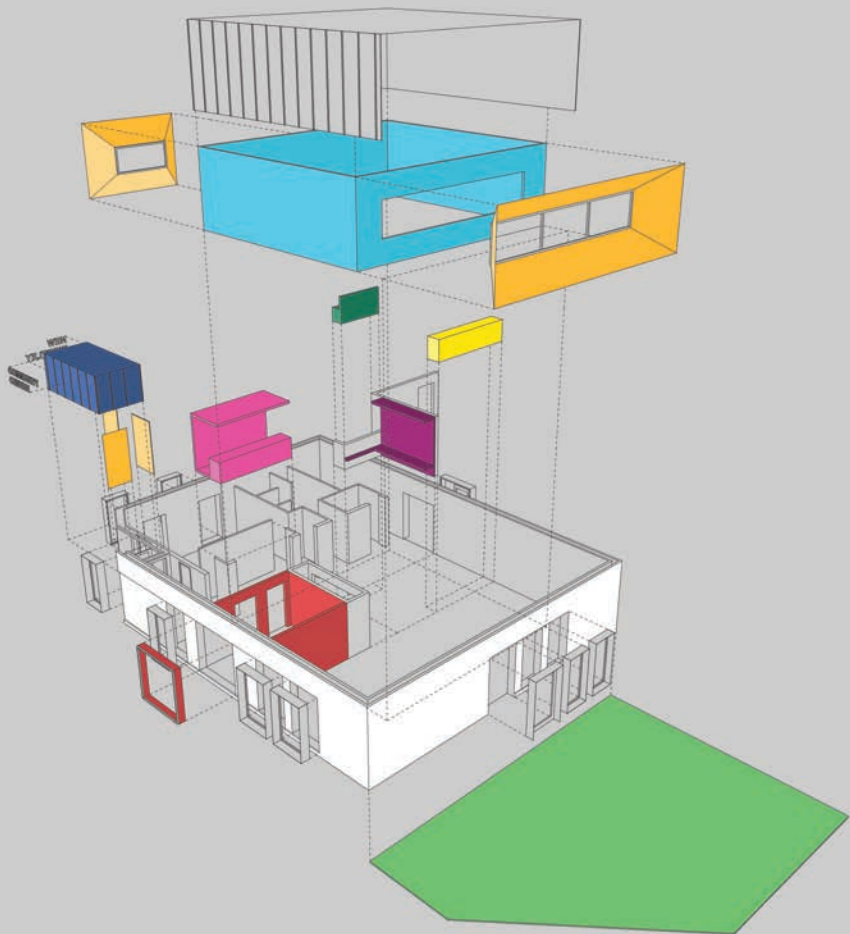

/ NEW WORTLEY COMMUNITY CENTRE

New Wortley Community Centre is a thriving community centre in Leeds. The project is for a new multi-purpose building that will enable the centre to expand its reach and sustain itself in the future. The existing building will be transformed into a well-being centre in a future phase.

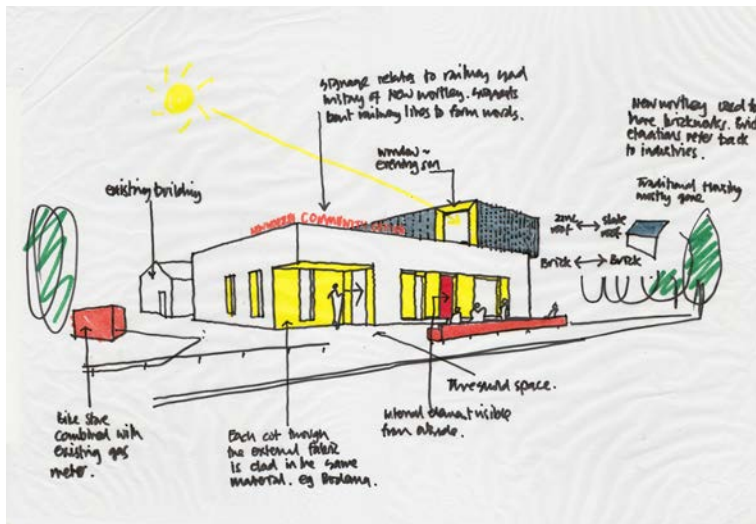

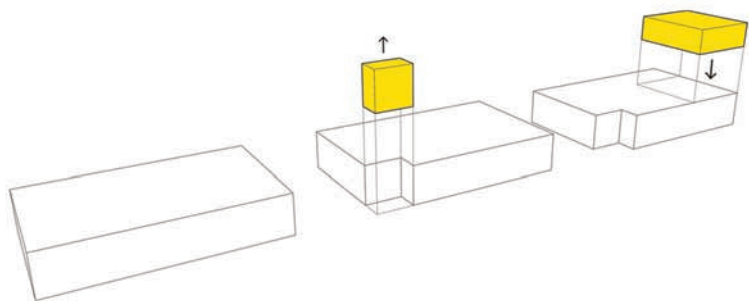
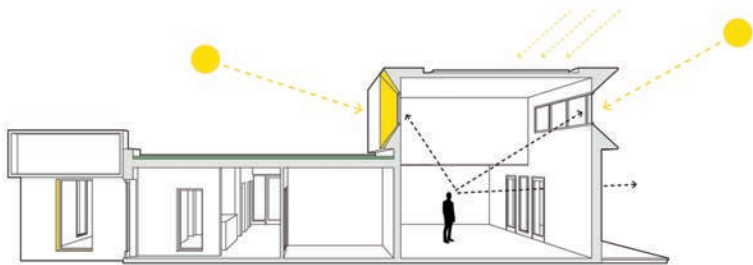

New Wortley Community Centre is a sustainable new building in a disadvantaged area of Leeds. Project Office worked with New Wortley Community Association to secure more than £800,000 of grant funding from Big Lottery to design and construct the building. The construction phase began in August 2015 and will be completed in Spring 2016. Throughout the design stages of the project students and academics, from the School of Art, Architecture and Design provided consultancy and design services. Our collaborative approach produced an exemplar method of working, broadly termed *co-design*, and this resulted in an inspiring, distinctive, thoughtful and durable building.

The project has developed following Vahagn Mkrtchyan's winning submission for the in-house design competition in 2010. We recognise Leeds Beckett University's students immense contribution in helping to raise the funding and for all the architectural and design input at the various stages of the project. Students from a range of design courses will be involved in the implementation of some of the building's elements during its construction.



New Wortley Community Centre on site - September 2016



Live projects
are very good at
exercising and
developing spatial
intelligence,
a skill and
understanding that
is absolutely
central to
architectural
education.



01/ FareShare



02/ Arc Light_Orwin House



03/ BasementArts Project



04/ Old Chapel Studios



05/ House of Hope Haiti



06/ Garden Gate Hunslet



07/ Hunslet Urban Framework



08/ The Orangery_Beam



09/ Bardsey Scout Hut

Sketch by Christina Vafeiadi - BA(Hons) Architecture

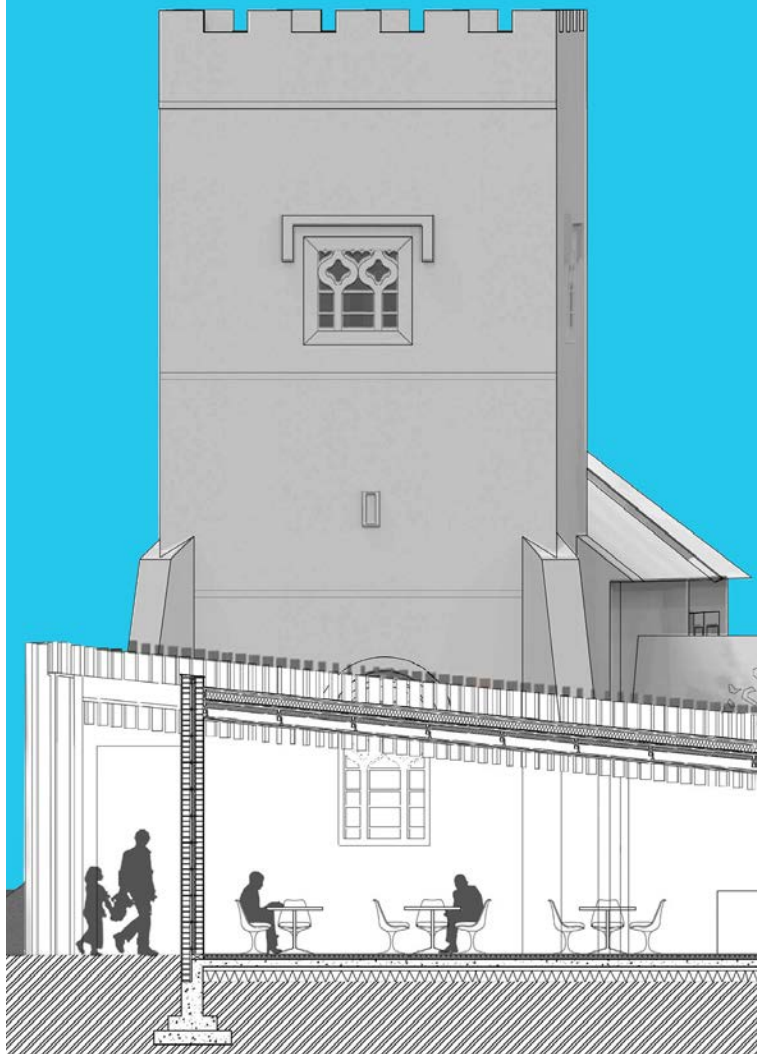

/ NUNBURNHOLME

Nunburnholme is a small village in rural East Yorkshire with a population of approximately 200 and a rich history including the first nunnery to be closed by Henry VIII and the founding of The Royal Society for the Protection of Birds by Reverend Francis Orpen Morris. At present the villagers have no shared amenity, other than the church.

BA2 students were tasked with fulfilling the aspirations of Nunburnholme Village Group: the vision is to create a building and surrounding environment that can serve as a magnet and a fulcrum to unite, enrich, and sustain the vibrancy of the village and surrounding communities. A building that is sensitive to the land of the Yorkshire Wolds it will inhabit, and evocative of the history and nature of the area.

/ FILM SCHOOL

The proposal for a new Film, Music & Performing Arts School for Leeds Beckett University is at this stage only a hypothetical project but it has a purpose, to develop and inform the school's staff and students ability and capacity to engage with an actual relocation project in the future. Three unique 'design guides' have been produced by three teams of postgraduate architecture students.



Sketch by Christopher Newbold - MARCH







Primary school pupils and architecture students worked together in the classroom to create the Design Guide for a 'playscape' of imaginative play and learning. This was used as the brief for an ideas competition, open to the school of architecture's alumni.

Two winning entries of Bradley Spencer and Ashley Ball were selected by the school and imaginatively combined, developed, detailed and hand-crafted on site by a team of architecture students. The playscape has three discrete elements; a theatre space, secret garden and bell tower, all predominantly constructed from European oak, pine decking and marine plywood.

In total some 40 students participated; gaining real life experience of brief writing, design of concept, construction detailing, and 'on-site' assembly. The live project exposed students to a design methodology that puts team working and collaboration at the heart of the creative experience.

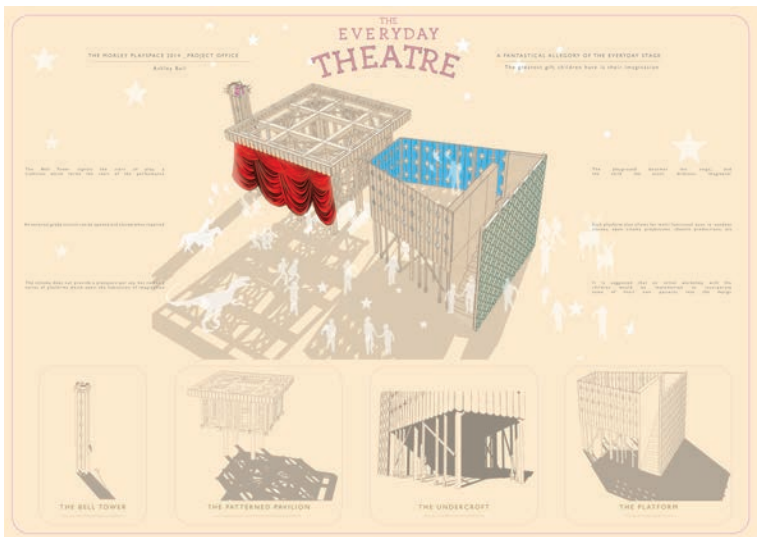

Competition Entry by Ashley Ball



Construction Sequence of Theatre Space

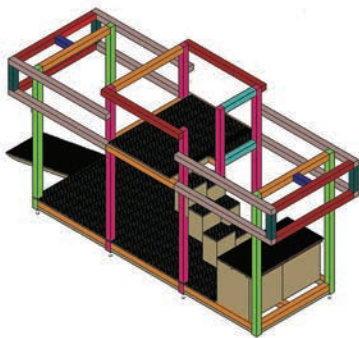
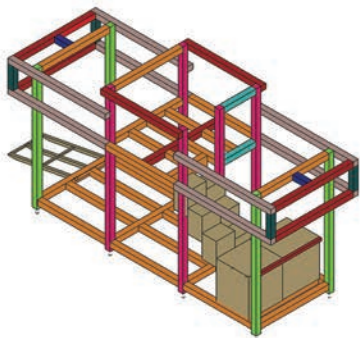
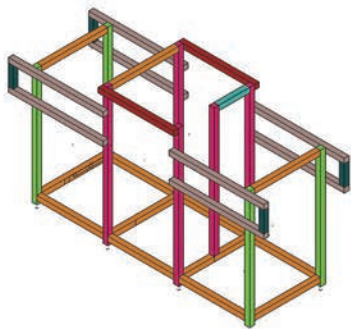
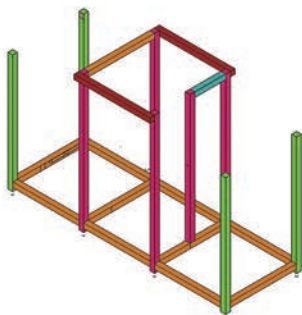
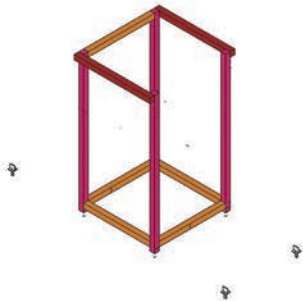
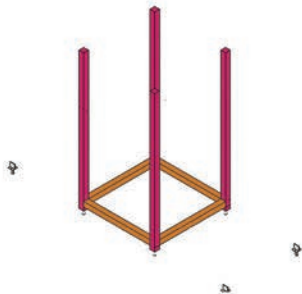

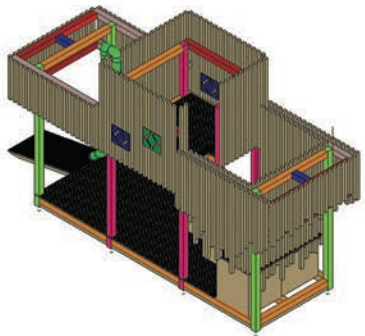
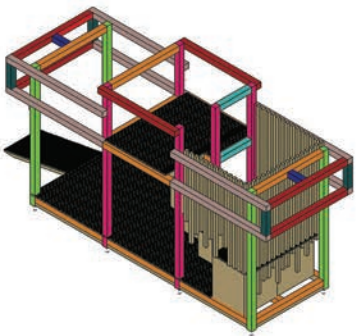
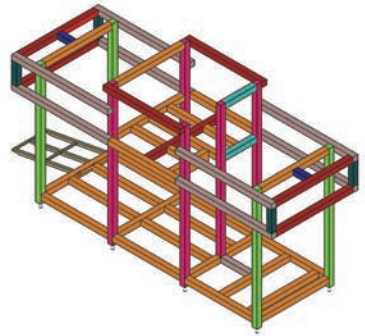
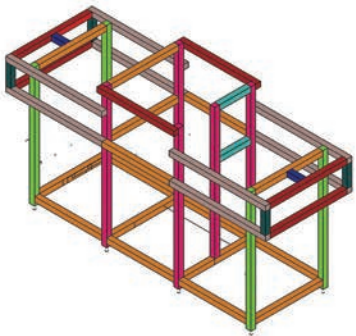
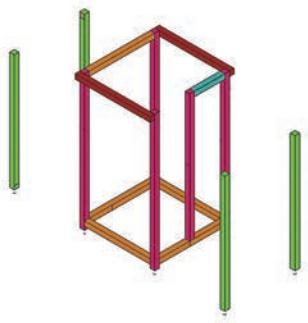
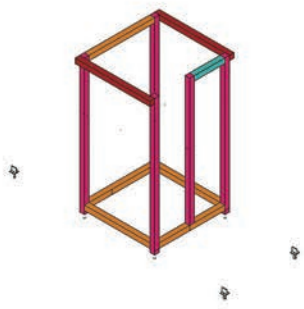

So often [an
architecture]
school is caught
up with ideas of
what architects
are supposed
to be, without
acknowledging how
they actually have
to operate in the
world.

/ PROJECT PARTICIPANTS

STUDENTS

Adesina Adebauke
Alexander Adrienne
Ryan Ainsley
Spencer Alex
Ben Alexander
Beatriz Arbex
Joshua Arthur
Nushoor Al-Mahoozi
Vanessa Baer
Ashley Ball
Heaven Belay
Sam Bedford
Rachel Berry
Scott Bingham
Jacob Bojunc
Rebecca Brett
Marilia Cavalcanti
Farias
Junayd Chaudhary
Duncan Colf
Josemar Da Costa
Asma Dauleh
Graham Davey
Emily Daye
Marina De Araujo
Patury
Carolina De Bastiani
Grubert
Luiza De Melo
Lauren Di Pietro
Malaika Donkor
Oliver Dykes
Joseph Earley
Tom Eddison
Patricia Escano
Amy Featherstone
Petrus Fernandes
Chris Foster
Freddie Garside
Zahra Haghajat
Lylyan Hamodi
Jack Hartley
Sarah Harvey
Maria Herminia
Robyn Holden
Nick Husband
Lana Ismail
Joshua Jenje
Mathew Kan

Tony Kangah
Howard Kent
Ana Paula Kouzak
Kamila Kudlata
Matteo Lattanzio
Ylana Leal Melo de
Oliveira
Nandara Mendes Gomes
Nathalia Menezes
Silva
Larissa Monteiro
Rod Neto
Christopher Newbold
Adrian O'Hagan
Roberts Opincans
Agnesa Osmani
Joao Otoni Cardoso
Chris Paraskos
Piotr Pich
Vavara Politi
Lais Porcino Dos
Passos
Matt Riley
Paula Rodrigues
Felipe Rossi Ferreira
Nils Schmidt-Hansen
Matt Shepherd
Bradley Spencer
Victoria Tainty
Julia Temponi
Arpeeta Thakur
Andrew Thompson
Max Timms
Rebecca Turner
Paul Unett
Christina Vafeiadi
Zachariah Wall
Ziemann Wendt
Anastasia Whitehead
Stephanie Wilding
Vinicius Wolff Suda

TUTORS

Petros Tsitnidis
Juha Kaapa
Dr Maria Theodorou
Craig Stott
Simon Warren

ORGANISATIONS

Big Lottery
Leeds Beckett
University

CONSULTANTS / CONTRACTORS

Bernard Williams
Associates
Adept CSCE
AGM Safety Ltd
Preston Barber
Wates Construction
Guy Harnett
Michael Wadsworth

FRIENDS

Professor Alan Simson
Adrian Appleyard
Alan Stoyles
LoneStar
Peter Dixon
Andrew Raby
Leeds Beckett
University Film,
Music & Performing
Arts School
Janet Mulcrone

CLIENTS

New Wortley Community
Association
Morley Newlands
Primary School
Nunburnholme Village
1st Bardsey Scout
Group



Project Office
Leeds Beckett University
B504, Broadcasting Place
Woodhouse Lane
Leeds
LS2 9EN

+44 (0)113 81 26752
projectoffice@leedsbeckett.ac.uk
twitter: @_projectoffice
cagd.co.uk/projectoffice